

Plan 1:100

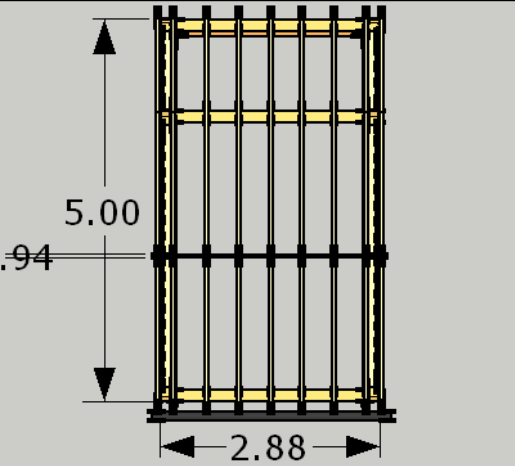

Front Elevation 1:100

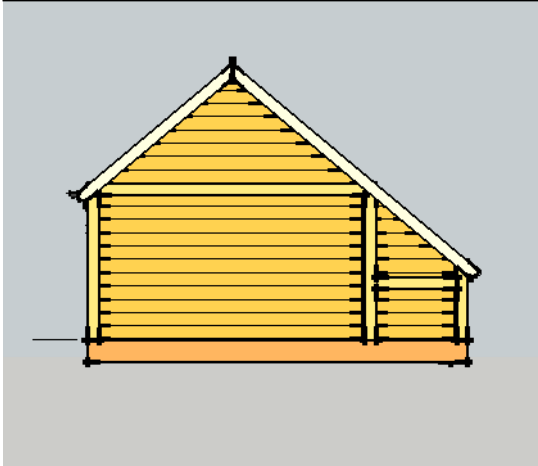

Isometric 1:50

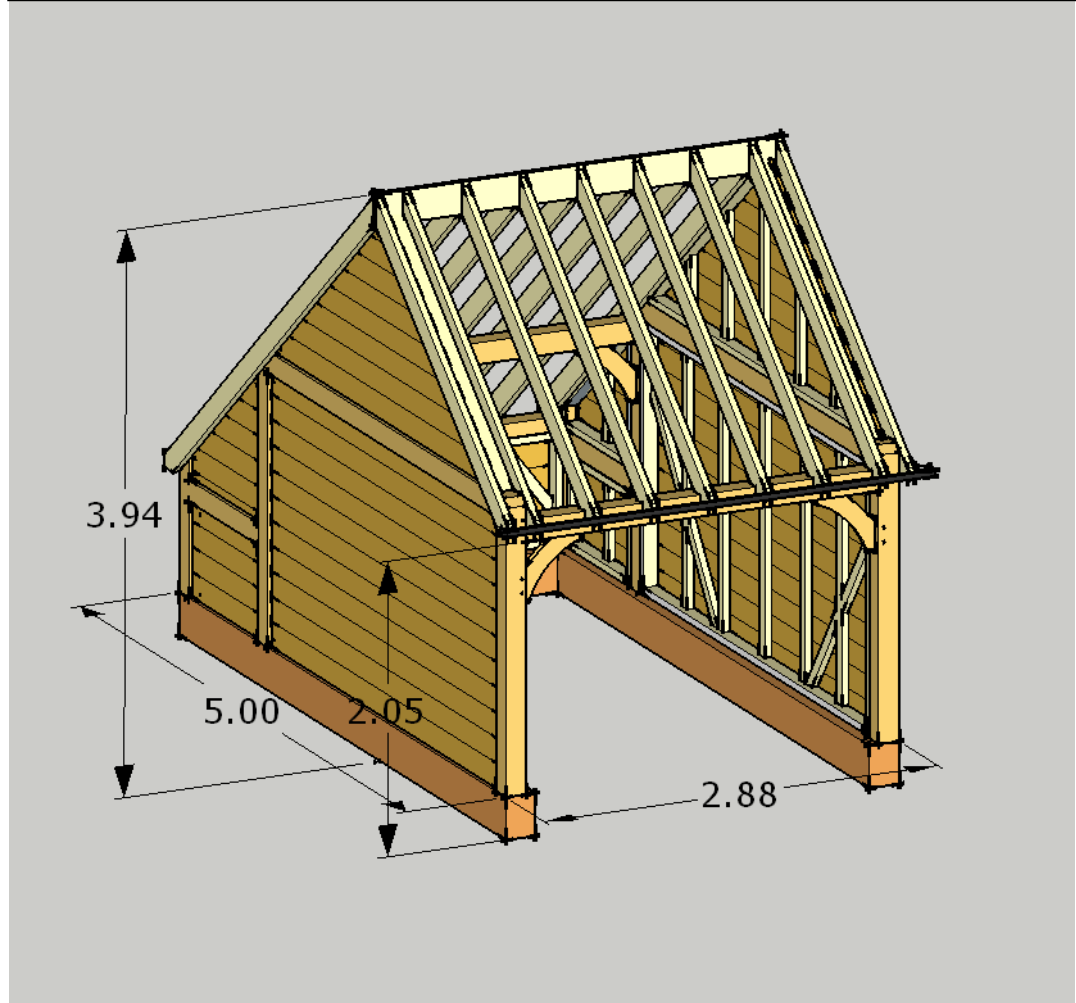

Side Elevation 1:100

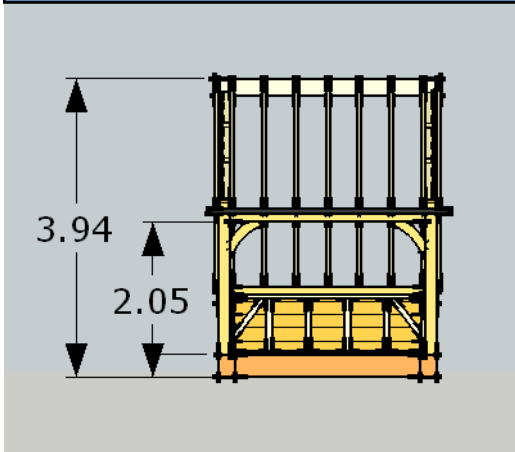

Rear Elevation 1:100

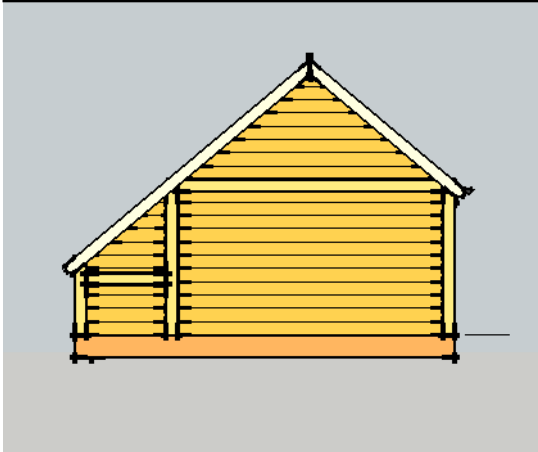

© CHS Landscape Design

Drawing No:
Revision:
Date drawn:
Drawn by:
Project title:
Client :
Drawing Title:

Notes:

This is a sketch design showing an overview of the proposed layout. Please agree with client on the ground prior to implementing anything illustrated here. This drawing is the copyright of the designers and can not be reproduced without their consent.